



**ersabar**®  
Modular Boring Bar System



**PRODUCT SUPPLEMENT**  
**2020**

# THE VERSABAR® ADVANTAGE

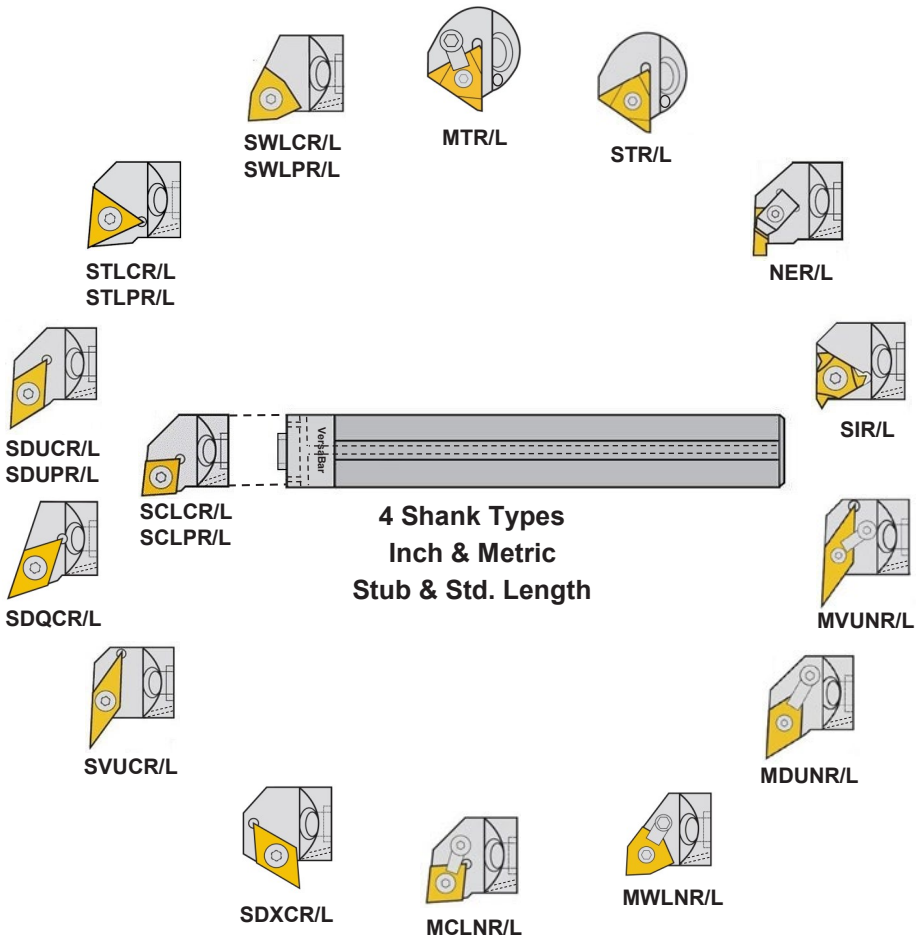

## TOTAL VERSATILITY!

All products MADE IN USA  
Versabar® is a trademark of Versabar Tools, LLC  
This supplement property of ToolSaver, Inc  
© 2019 All rights reserved

# System Overview:

- 📄 Steel, Carbide & Heavy Metal Shanks
- 📄 Range .375" - 1.250" Shank Diameter - Inch
- 📄 M10 - M32 Shank Diameter - Metric
- 📄 5:1 & 8:1 L/D Reach
- 📄 RH & LH Heads Mount Same Shank
- 📄 Same Head Mounts To Inch Or Metric Shank
- 📄 38 Head Options
- 📄 Quick Change - Single Screw
- 📄 Pockets Utilize Popular ANSI/ISO Inserts
- 📄 Reduction Adapter
- 📄 Shank Retrofitting Available



**Versabar® Shanks Utilized For Multiple Machining Operations With Fast Head Change**

# NOMENCLATURE BORING HEADS

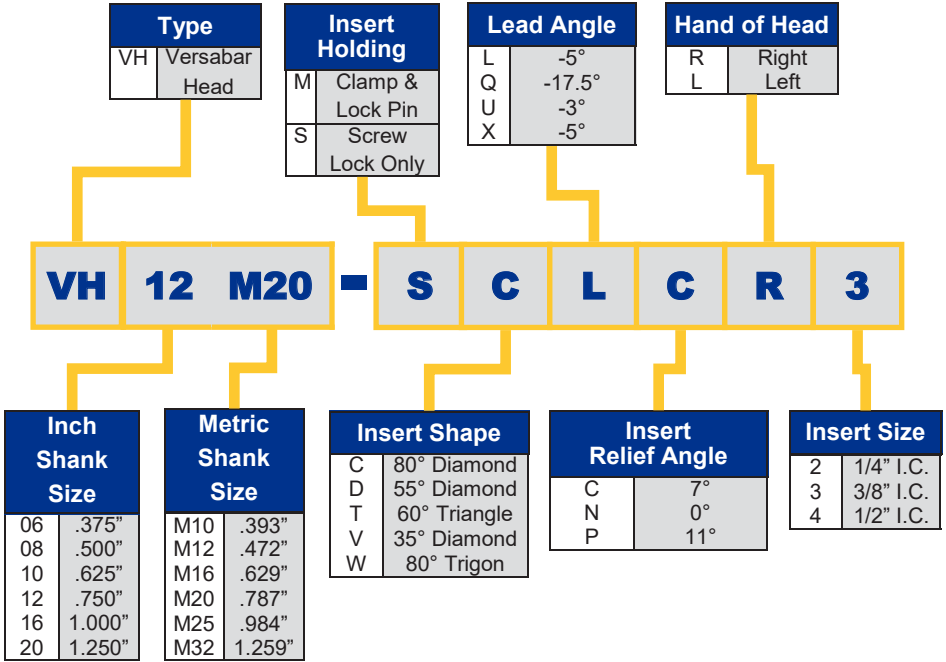

**Versabar® Shanks Adapt To Capto® And KM  
Using A Boring Bar Adapter Combined With Split Sleeve Bushing**



# ersabar® Heads - Positive Rake

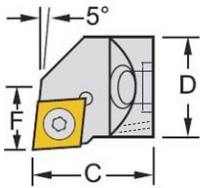

RH Head Shown

Positive 80° Diamond  
CCMT Insert  
-5° Lead  
Coolant Fed

## VH-SCLCR/L

Designation	Gage Insert	Min Bore	D	C	F	Insert Screw	PRICE
VH06M10-SCLCR/L2	CCMT-21.51	.465	.375	.625	.250	IS25	\$120.00
VH08M12-SCLCR/L2	CCMT-21.51	.590	.500	.750	.312	IS25	\$125.00
VH08M12-SCLCR/L3	CCMT-32.52	.590	.500	.750	.312	IS35	\$125.00
VH10M16-SCLCR/L3	CCMT-32.52	.750	.625	.875	.406	IS35	\$130.00
VH12M20-SCLCR/L3	CCMT-32.52	.905	.750	1.125	.500	IS35	\$135.00
VH16M25-SCLCR/L3	CCMT-32.52	1.17	1.00	1.250	.640	IS35	\$140.00

VH06M10 Heads Coolant Optional Upon Request  
Same Head Mounts To Inch Or Metric Shank

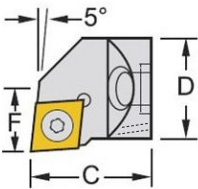

RH Head Shown

Positive 80° Diamond  
CPMT Insert  
-5° Lead  
Coolant Fed

## VH-SCLPR/L

Designation	Gage Insert	Min Bore	D	C	F	Insert Screw	PRICE
VH06M10-SCLPR/L2	CPMT-21.51	.465	.375	.625	.250	IS25	\$120.00
VH08M12-SCLPR/L2	CPMT-21.51	.590	.500	.750	.312	IS25	\$125.00
VH08M12-SCLPR/L3	CPMT-32.52	.590	.500	.750	.312	IS35	\$125.00
VH10M16-SCLPR/L3	CPMT-32.52	.750	.625	.875	.406	IS35	\$130.00
VH12M20-SCLPR/L3	CPMT-32.52	.905	.750	1.125	.500	IS35	\$135.00
VH16M25-SCLPR/L3	CPMT-32.52	1.17	1.00	1.250	.640	IS35	\$140.00

VH06M10 Heads Coolant Optional Upon Request  
Same Head Mounts To Inch Or Metric Shank



# ersabar® Heads - Positive Rake

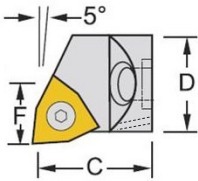

RH Head Shown

Positive Trigon  
WCMT Insert  
-5° Lead  
Coolant Fed

## VH-SWLCR/L

Designation	Gage Insert	Min Bore	D	C	F	Insert Screw	PRICE
VH06M10-SWLCR/L2	WCMT-21.51	.465	.375	.625	.250	IS25	\$120.00
VH08M12-SWLCR/L2	WCMT-21.51	.590	.500	.750	.312	IS25	\$125.00
VH10M16-SWLCR/L3	WCMT-32.52	.750	.625	.875	.406	IS35	\$130.00
VH12M20-SWLCR/L3	WCMT-32.52	.905	.750	1.125	.500	IS35	\$135.00
VH16M25-SWLCR/L3	WCMT-32.52	1.17	1.00	1.250	.640	IS35	\$140.00

VH06M10 Heads Coolant Optional Upon Request  
Same Head Mounts To Inch Or Metric Shank

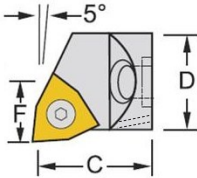

RH Head Shown

Positive Trigon  
WPMT Insert  
-5° Lead  
Coolant Fed

## VH-SWLPR/L

Designation	Gage Insert	Min Bore	D	C	F	Insert Screw	PRICE
VH06M10-SWLPR/L2	WPMT-21.51	.465	.375	.625	.250	IS25	\$120.00
VH08M12-SWLPR/L2	WPMT-21.51	.590	.500	.750	.312	IS25	\$125.00
VH10M16-SWLPR/L3	WPMT-32.52	.750	.625	.875	.406	IS35	\$130.00
VH12M20-SWLPR/L3	WPMT-32.52	.905	.750	1.125	.500	IS35	\$135.00
VH16M25-SWLPR/L3	WPMT-32.52	1.17	1.00	1.250	.640	IS35	\$140.00

VH06M10 Heads Coolant Optional Upon Request  
Same Head Mounts To Inch Or Metric Shank



# ersabar® Heads - Positive Rake

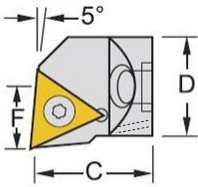

Positive Triangle  
TCMT Insert  
-5° Lead  
Coolant Fed

RH Head Shown

## VH-STLCR/L

Designation	Gage Insert	Min Bore	D	C	F	Insert Screw	PRICE
VH06M10-STLCR/L2	TCMT-21.51	.465	.375	.625	.250	IS25	<b>\$120.00</b>
VH08M12-STLCR/L2	TCMT-21.51	.590	.500	.750	.312	IS25	<b>\$125.00</b>
VH10M16-STLCR/L2	TCMT-21.51	.750	.625	.875	.406	IS25	<b>\$130.00</b>
VH12M20-STLCR/L3	TCMT-32.52	.905	.750	1.125	.500	IS35	<b>\$135.00</b>
VH16M25-STLCR/L3	TCMT-32.52	1.17	1.00	1.250	.640	IS35	<b>\$140.00</b>

VH06M10 Heads Coolant Optional Upon Request  
Same Head Mounts To Inch Or Metric Shank

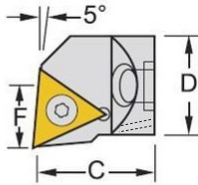

Positive Triangle  
TPMT Insert  
-5° Lead  
Coolant Fed

RH Head Shown

## VH-STLPR/L

Designation	Gage Insert	Min Bore	D	C	F	Insert Screw	PRICE
VH06M10-STLPR/L2	TPMT-21.51	.465	.375	.625	.250	IS25	<b>\$120.00</b>
VH08M12-STLPR/L2	TPMT-21.51	.590	.500	.750	.312	IS25	<b>\$125.00</b>
VH10M16-STLPR/L2	TPMT-21.51	.750	.625	.875	.406	IS25	<b>\$130.00</b>
VH12M20-STLPR/L3	TPMT-32.52	.905	.750	1.125	.500	IS35	<b>\$135.00</b>
VH16M25-STLPR/L3	TPMT-32.52	1.17	1.00	1.250	.640	IS35	<b>\$140.00</b>

VH06M10 Heads Coolant Optional Upon Request  
Same Head Mounts To Inch Or Metric Shank





# ersabar® Heads - Positive Rake

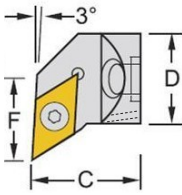

RH Head Shown

Positive 55° Diamond  
DCMT Insert  
-3° Lead  
Coolant Fed

## VH-SDUCR/L

Designation	Gage Insert	Min Bore	D	C	F	Insert Screw	PRICE
VH06M10-SDUCR/L2	DCMT-21.51	.585	.375	.625	.375	IS25	<b>\$120.00</b>
VH08M12-SDUCR/L2	DCMT-21.51	.710	.500	.750	.437	IS25	<b>\$125.00</b>
VH10M16-SDUCR/L3	DCMT-32.52	.835	.625	.875	.500	IS35	<b>\$130.00</b>
VH12M20-SDUCR/L3	DCMT-32.52	.960	.750	1.125	.562	IS35	<b>\$135.00</b>
VH16M25-SDUCR/L3	DCMT-32.52	1.28	1.00	1.250	.750	IS35	<b>\$140.00</b>

VH06M10 Heads Coolant Optional Upon Request  
Same Head Mounts To Inch Or Metric Shank

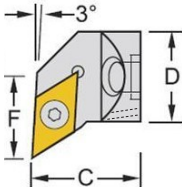

RH Head Shown

Positive 55° Diamond  
DPMT Insert  
-3° Lead  
Coolant Fed

## VH-SDUPR/L

Designation	Gage Insert	Min Bore	D	C	F	Insert Screw	PRICE
VH06M10-SDUPR/L2	DPMT-21.51	.585	.375	.625	.375	IS25	<b>\$120.00</b>
VH08M12-SDUPR/L2	DPMT-21.51	.710	.500	.750	.437	IS25	<b>\$125.00</b>
VH10M16-SDUPR/L3	DPMT-32.52	.835	.625	.875	.500	IS35	<b>\$130.00</b>
VH12M20-SDUPR/L3	DPMT-32.52	.960	.750	1.125	.562	IS35	<b>\$135.00</b>
VH16M25-SDUPR/L3	DPMT-32.52	1.28	1.00	1.250	.750	IS35	<b>\$140.00</b>

VH06M10 Heads Coolant Optional Upon Request  
Same Head Mounts To Inch Or Metric Shank





# ersabar® Heads - Positive Rake

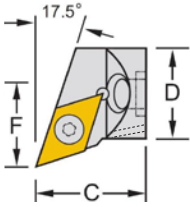

Positive 55° Diamond  
DCMT Insert  
-17.5° Lead  
Coolant Fed

RH Head Shown

## VH-SDQCR/L

Designation	Gage Insert	Min Bore	D	C	F	Insert Screw	PRICE
VH08M12-SDQCR/L2	DCMT-21.51	.615	.500	.750	.341	IS25	\$135.00
VH10M16-SDQCR/L2	DCMT-21.51	.750	.625	.875	.406	IS25	\$140.00
VH12M20-SDQCR/L2	DCMT-21.51	.870	.750	1.125	.468	IS25	\$145.00
VH16M25-SDQCR/L3	DCMT-32.52	1.15	1.00	1.250	.625	IS35	\$150.00

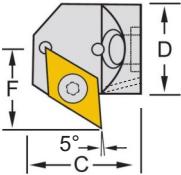

Positive 55° Diamond  
DCMT Insert  
-5° Lead (Back Face)  
Coolant Fed

RH Head Shown

## VH-SDXCR/L

Designation	Gage Insert	Min Bore	D	C	F	Insert Screw	PRICE
VH08M12-SDXCR/L2	DCMT-21.51	.710	.500	.750	.437	IS25	\$135.00
VH10M16-SDXCR/L2	DCMT-21.51	.835	.625	.875	.500	IS35	\$140.00
VH12M20-SDXCR/L3	DCMT-32.52	.960	.750	1.125	.562	IS35	\$145.00
VH16M25-SDXCR/L3	DCMT-32.52	1.28	1.00	1.250	.750	IS35	\$150.00

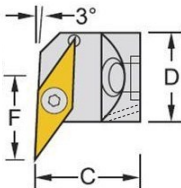

Positive 35° Diamond  
VBMT/VCMT Insert  
-3° Lead  
Coolant Fed

RH Head Shown

## VH-SVUCR/L

Designation	Gage Insert	Min Bore	D	C	F	Insert Screw	PRICE
VH08M12-SVUCR/L2	VBMT/VCMT-221	.740	.500	.750	.470	IS25	\$135.00
VH10M16-SVUCR/L2	VBMT/VCMT-221	.850	.625	.875	.500	IS25	\$140.00
VH12M20-SVUCR/L2	VBMT/VCMT-221	.970	.750	1.125	.562	IS25	\$145.00
VH16M25-SVUCR/L3	VBMT/VCMT-332	1.28	1.00	1.250	.750	IS35	\$150.00



# ersabar® Heads - Negative Rake

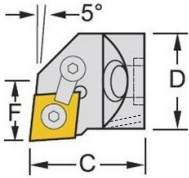

Negative 80° Diamond  
CNMG Insert  
-5° Lead  
Coolant Fed

RH Head Shown

## VH-MCLNR/L

Designation	Gage	Min				Lockpin	Shim	Clamp	Clamp Screw	PRICE
	Insert	Bore	D	C	F					
VH12M20-MCLNR/L3	CNMG-322	.920	.750	1.125	.500	NL-33	—	—	—	\$140.00
VH16M25-MCLNR/L4	CNMG-432	1.200	1.00	1.250	.640	NL-44	—	CL-5	XNS-35	\$155.00
VH20M32-MCLNR/L4	CNMG-432	1.470	1.25	1.750	.765	NL-46	ICSN-433	CL-20	XNS-47	\$170.00

Same Head Mounts To Inch Or Metric Shank

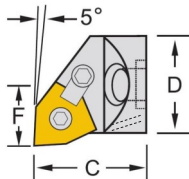

Negative Trigon  
WNMG Insert  
-5° Lead  
Coolant Fed

RH Head Shown

## VH-MWLNR/L

Designation	Gage	Min				Lockpin	Shim	Clamp	Clamp Screw	PRICE
	Insert	Bore	D	C	F					
VH12M20-MWLNR/L3	WNMG-332	.920	.750	1.125	.500	NL-33L	—	—	—	\$140.00
VH16M25-MWLNR/L4	WNMG-432	1.200	1.00	1.250	.640	NL-44	—	CL-5	XNS-35	\$155.00
VH20M32-MWLNR/L4	WNMG-432	1.470	1.25	1.750	.765	NL-46	IWSN-433	CL-20	XNS-47	\$170.00

Same Head Mounts To Inch Or Metric Shank

# ersabar® Heads - Negative Rake

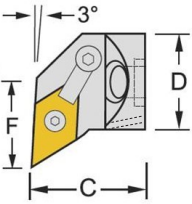

RH Head Shown

Negative 55° Diamond  
DNMG Insert  
-3° Lead  
Coolant Fed

## VH-MDUNR/L

Designation	Gage	Min				Lockpin	Shim	Clamp	Clamp Screw	PRICE
	Insert	Bore	D	C	F					
VH12M20-MDUNR/L3	DNMG-332	1.050	.750	1.125	.562	NL-33L	—	—	—	\$140.00
VH16M25-MDUNR/L3	DNMG-332	1.300	1.00	1.250	.750	NL-33L	—	CL-5	XNS-35	\$155.00
VH20M32-MDUNR/L4	DNMG-432	1.700	1.25	1.750	1.000	NL-46	IDSN-433	CL-20	XNS-47	\$170.00

Same Head Mounts To Inch Or Metric Shank

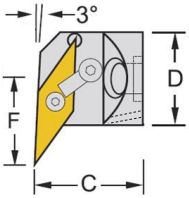

RH Head Shown

Negative 35° Diamond  
VNMG Insert  
-3° Lead  
Coolant Fed

## VH-MVUNR/L

Designation	Gage	Min				Lockpin	Shim	Clamp	Clamp Screw	PRICE
	Insert	Bore	D	C	F					
VH16M25-MVUNR/L3	VNMG-332	1.350	1.00	1.250	.750	NL-33L	—	CL-5	XNS-35	\$155.00
VH20M32-MVUNR/L3	VNMG-332	1.700	1.25	1.750	1.000	NL-34L	IVSN-322	CL-20	XNS-47	\$170.00

Same Head Mounts To Inch Or Metric Shank

# NOMENCLATURE THREADING/GROOVING HEADS

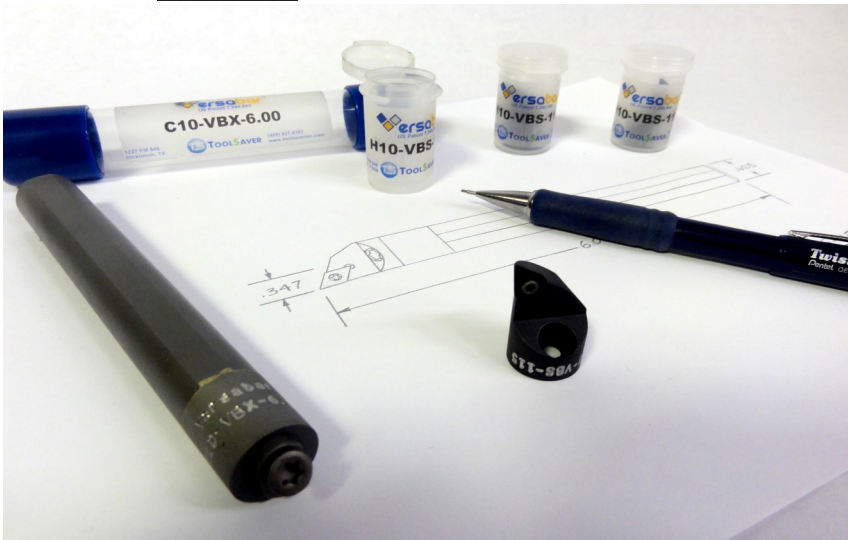
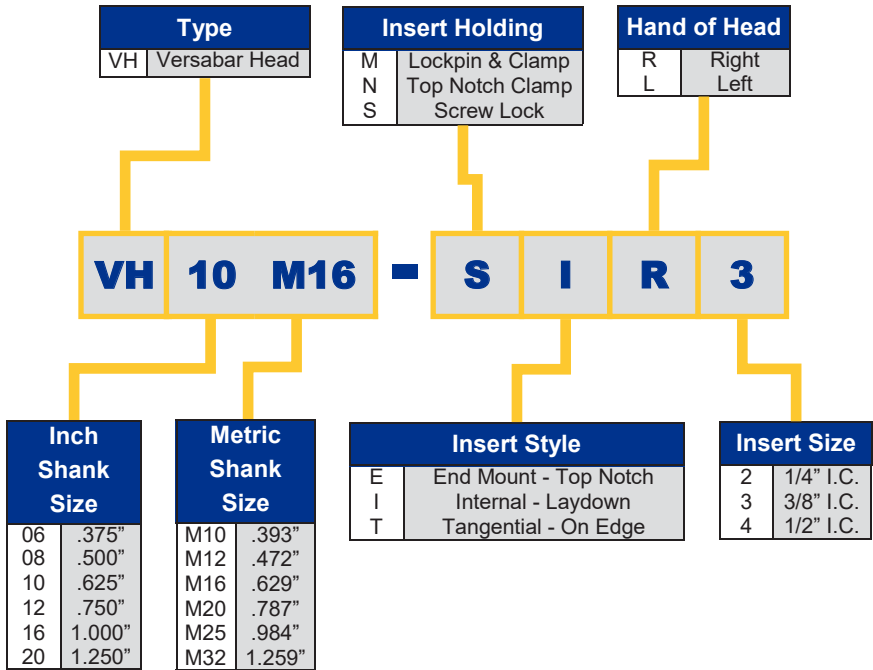

**Special Versabar® Heads Available Upon Request**

# ersabar® Heads - Threading/Grooving

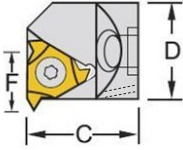

RH Head Shown

Laydown Triangle  
**1.5° Helix Angle**  
**Coolant Fed**

## VH-SIR/L

Designation	Gage Insert	Min Bore	D	C	F	Insert Screw	Anvil Screw		Anvil		PRICE
							RH	LH	RH	LH	
VH06M10-SIR/L2	1/4" IC	.470	.375	.625	.260	SN2T	—	—	—	—	\$130.00
VH08M12-SIR/L2	1/4" IC	.580	.500	.875	.340	SN2T	—	—	—	—	\$135.00
VH10M16-SIR/L3	3/8" IC	.780	.625	.875	.450	SN3T	—	—	—	—	\$140.00
VH12M20-SIR/L3	3/8" IC	.900	.750	1.125	.510	SN3T	—	—	—	—	\$145.00
VH16M25-SIR/L3	3/8" IC	1.17	1.00	1.250	.650	SA3T	SY3T	YI3	YE3	—	\$155.00
VH16M25-SIR/L4	1/2" IC	1.23	1.00	1.250	.710	SA4T	SY4T	YI4	YE4	—	\$160.00
VH20M32-SIR/L3	3/8" IC	1.42	1.25	1.750	.770	SA3T	SY3T	YI3	YE3	—	\$170.00
VH20M32-SIR/L4	1/2" IC	1.50	1.25	1.750	.850	SA4T	SY4T	YI4	YE4	—	\$175.00

**VH06M10 Heads Coolant Optional Upon Request**  
**Same Head Mounts To Inch Or Metric Shank**

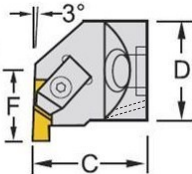

RH Head Shown

**Top-Notch® / Flo-Lock®**  
**-3° Lead**  
**Coolant Fed**

## VH-NER/L

Designation	Gage Insert	Min Bore	D	C	F	Clamp		Clamp Screw	PRICE
						RH	LH		
VH08M12-NER/L2	N..2 R/L	.730	.500	.875	.437	CM75	CM74	B632	\$140.00
VH10M16-NER/L2	N..2 R/L	1.00	.625	1.000	.500	CM75	CM74	C632	\$145.00
VH12M20-NER/L2	N..2 R/L	1.12	.750	1.125	.562	CM75	CM74	C632	\$155.00
VH16M25-NER/L3	N..3 R/L	1.37	1.00	1.500	.688	CM73	CM72	C1032	\$170.00
VH20M32-NER/L3	N..3 R/L	1.75	1.25	1.750	.875	CM73	CM72	C1032	\$185.00

**Same Head Mounts To Inch Or Metric Shank**

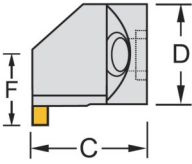

On-Edge Triangle  
TNMA Insert  
Lockpin & Clamp  
Coolant Fed

RH Head Shown

### VH-MTR/L

Designation	Gage Insert	Min Bore	D	C	F	Lockpin	Clamp	Clamp Screw	PRICE
VH12M20-MTR/L3	TNMA-32...R/L	1.20	.750	1.125	.562	NL-33	CL-5	XNS-35	<b>\$160.00</b>
VH16M25-MTR/L3	TNMA-32...R/L	1.40	1.00	1.250	.687	NL-33	CL-5	XNS-35	<b>\$175.00</b>
VH16M25-MTR/L4	TNMA-43...R/L	1.65	1.00	1.250	.750	NL-44	CL-5	XNS-35	<b>\$175.00</b>
VH20M32-MTR/L3	TNMA-32...R/L	1.75	1.25	1.750	.800	NL-33	CL-5	XNS-35	<b>\$190.00</b>
VH20M32-MTR/L4	TNMA-43...R/L	1.81	1.25	1.750	.875	NL-44	CL-20	XNS-47	<b>\$190.00</b>

Same Head Mounts To Inch Or Metric Shank

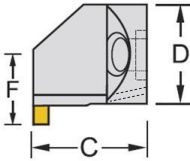

On-Edge Triangle (C'Sink)  
TNMC Insert  
Screw Only  
Coolant Fed

RH Head Shown

### VH-STR/L

Designation	Gage Insert	Min Bore	D	C	F	Insert Screw	PRICE
VH12M20-STR/L3	TNMC-32...R/L	1.20	.750	1.125	.562	GTS1	<b>\$155.00</b>
VH16M25-STR/L3	TNMC-32...R/L	1.40	1.00	1.250	.687	GTS1	<b>\$170.00</b>
VH16M25-STR/L4	TNMC-43...R/L	1.65	1.00	1.250	.750	GTS2	<b>\$170.00</b>
VH20M32-STR/L3	TNMC-32...R/L	1.75	1.25	1.750	.800	GTS1	<b>\$185.00</b>
VH20M32-STR/L4	TNMC-43...R/L	1.81	1.25	1.750	.875	GTS2	<b>\$185.00</b>

Same Head Mounts To Inch Or Metric Shank

# NOMENCLATURE MODULAR SHANKS

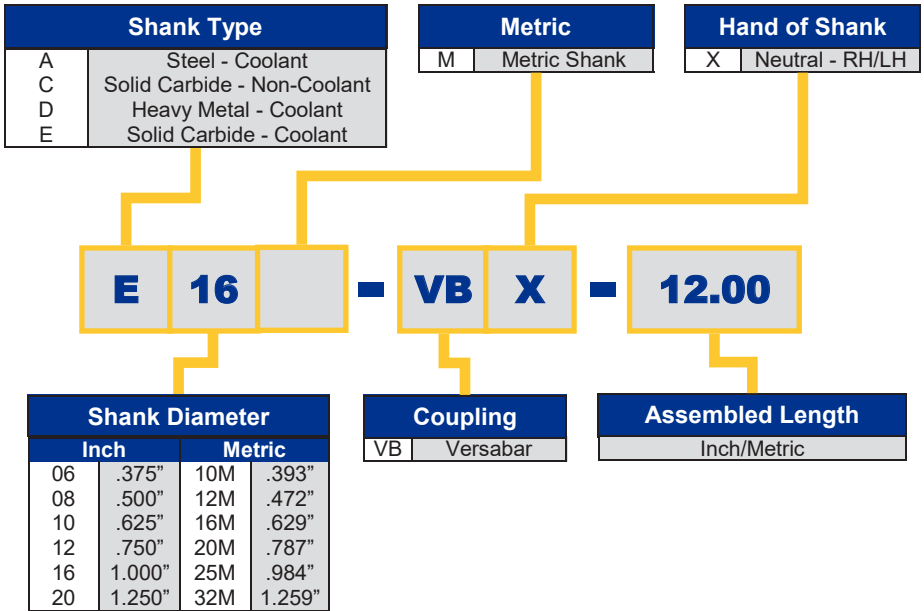

## Setup Tips

- In heavy threading or grooving applications and when extending the shank beyond 5:1 L/D, a split boring bar holder (or split sleeve bushing mounted in a standard boring bar holder) is the preferred clamping method as it minimizes vibration and protects the shank from point contact clamping. The split sleeve collapses around the shank, providing maximum contact.
- Periodically confirm that the coupling screw (securing the head on the shank) remains tight. Torque recommendations for coupling screws are:

Shank Size - 06 M10 (.375") = 25 inch lbs.  
 Shank Size - 08 M12 (.500") = 35 inch lbs.  
 Shank Size - 10 M16 (.625") = 50 inch lbs.  
 Shank Size - 12 M20 (.750") = 55 inch lbs.  
 Shank Size - 16 M25 (1.000") = 75 inch lbs.  
 Shank Size - 20 M32 (1.250") = 80 inch lbs.

- Versabar® Reduction Adapter (RH or LH) extends the reach of VH20/M32 shanks by 1.250" and allows for utilization of any VH16M25 modular head.



**“A” Style Steel Shank  
With Coolant**

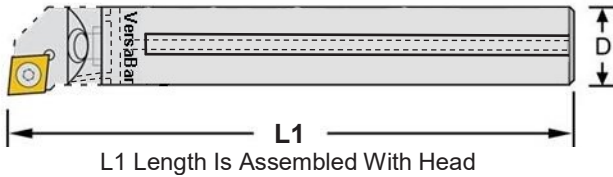

**A-VBX - ...**

Designation	D	L1	Maximum	Coupling	Key	PRICE
	Dia	Length	Reach	Screw		
A12-VBX-7.00	.750	7.00	4:1	CS12	T25	\$165.00
A16-VBX-8.00	1.000	8.00	4:1	CS16	M5	\$185.00
A20-VBX-10.00	1.250	10.00	4:1	CS20	1/4"	\$235.00

Note: VH16 Heads Sold Prior To This Supplement Use CS16T Coupling Screw

**“D” Style Heavy Metal Shank  
With Coolant**

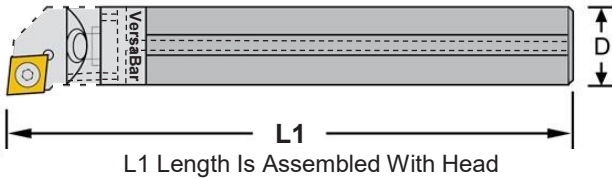

**D-VBX - ...**

Designation	D	L1	Maximum	Coupling	Key	PRICE
	Dia	Length	Reach	Screw		
D10-VBX-6.00	.625	6.00	5:1	CS10	T20	\$265.00
D12-VBX-7.00	.750	7.00	5:1	CS12	T25	\$355.00
D16-VBX-8.00	1.000	8.00	5:1	CS16	M5	\$495.00
D20-VBX-10.00	1.250	10.00	5:1	CS20	1/4"	\$1175.00

Note: VH16 Heads Sold Prior To This Supplement Use CS16T Coupling Screw

**“C” Style Carbide Shank - Metric  
No Coolant**

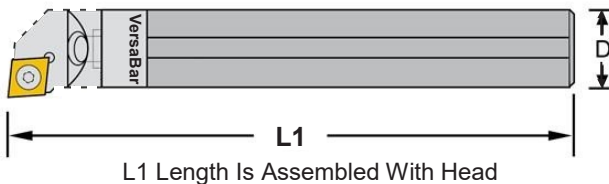

**C-VBX - ...**

Designation	D	L1	Maximum	Coupling	Key	PRICE
	Dia. Inch	Length MM	Reach	Screw		
C10M-VBX-125	.393	125	6:1	CS06	T15	\$110.00
C12M-VBX-125	.472	125	5:1	CS08	T20	\$165.00
C16M-VBX-150	.629	150	5:1	CS10	T25	\$245.00
C20M-VBX-175	.787	175	5:1	CS12	M5	\$315.00
C25M-VBX-195	.984	195	5:1	CS16	1/4"	\$455.00

Note: VH16 Heads Sold Prior To This Supplement Use CS16T Coupling Screw

**“C” Style Carbide Shank  
No Coolant**

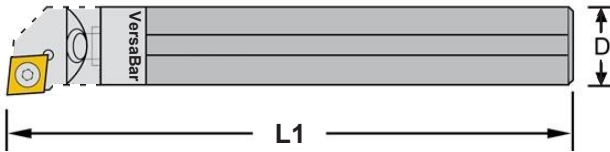

L1 Length Is Assembled With Head

**C-VBX - ...**

Designation	D	L1	Maximum	Coupling		
	Dia	Length	Reach	Screw	Key	PRICE
C06-VBX-4.00	.375	4.00	5:1	CS06	T9	\$110.00
C06-VBX-5.00	.375	5.00	6:1	CS06	T9	\$115.00
C06-VBX-6.00	.375	6.00	8:1	CS06	T9	\$120.00
C08-VBX-5.00	.500	5.00	5:1	CS08	T15	\$165.00
C08-VBX-6.00	.500	6.00	6:1	CS08	T15	\$185.00
C08-VBX-7.00	.500	7.00	8:1	CS08	T15	\$200.00
C10-VBX-6.00	.625	6.00	5:1	CS10	T20	\$245.00
C10-VBX-7.00	.625	7.00	6:1	CS10	T20	\$275.00
C10-VBX-8.00	.625	8.00	8:1	CS10	T20	\$305.00
C12-VBX-7.00	.750	7.00	5:1	CS12	T25	\$315.00
C12-VBX-10.00	.750	10.00	8:1	CS12	T25	\$425.00
C16-VBX-8.00	1.000	8.00	5:1	CS16	M5	\$455.00
C16-VBX-12.00	1.000	12.00	8:1	CS16	M5	\$645.00
C20-VBX-10.00	1.250	10.00	5:1	CS20	1/4"	\$1145.00
C20-VBX-14.00	1.250	14.00	8:1	CS20	1/4"	\$1345.00

Note: VH16 Heads Sold Prior To This Supplement Use CS16T Coupling Screw

**“E” Style Carbide Shank  
With Coolant**

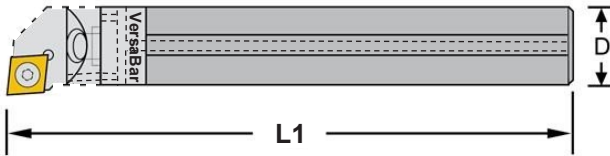

L1 Length Is Assembled With Head

**E-VBX - ...**

Designation	D	L1	Maximum	Coupling		
	Dia	Length	Reach	Screw	Key	PRICE
E06-VBX-4.00	.375	4.00	5:1	CS06	T9	\$120.00
E06-VBX-6.00	.375	6.00	8:1	CS06	T9	\$130.00
E08-VBX-5.00	.500	5.00	5:1	CS08	T15	\$175.00
E08-VBX-7.00	.500	7.00	8:1	CS08	T15	\$210.00
E10-VBX-6.00	.625	6.00	5:1	CS10	T20	\$255.00
E10-VBX-8.00	.625	8.00	8:1	CS10	T20	\$315.00
E12-VBX-7.00	.750	7.00	5:1	CS12	T25	\$345.00
E12-VBX-10.00	.750	10.00	8:1	CS12	T25	\$455.00
E16-VBX-8.00	1.000	8.00	5:1	CS16	M5	\$485.00
E16-VBX-12.00	1.000	12.00	8:1	CS16	M5	\$695.00
E20-VBX-10.00	1.250	10.00	5:1	CS20	1/4"	\$1195.00
E20-VBX-14.00	1.250	14.00	8:1	CS20	1/4"	\$1395.00

Note: VH16 Heads Sold Prior To This Supplement Use CS16T Coupling Screw



# ersabar® Reduction Adapter

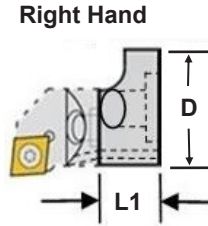
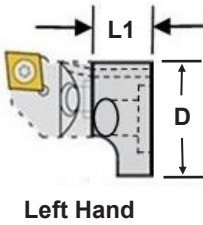

## RA-VBR/L- ...

Designation	D Dia	L1 Length	Front Coupling	Coupling Screw	Rear Coupling	PRICE
RA-VBR/L-20-16	1.250	1.250	16	CS16	20	\$165.00

When VH16 Heads Are Mounted To C20/E20 Shanks Add .125" To Head "F" Dimension and .250" to Min. Bore

Note: VH16 Heads Sold Prior To This Supplement Use CS16T Coupling Screw



# ersabar® Replacement Parts

Coupling Screws	Insert Screws Positive Rake		Insert Screws Laydown Threading				Anvil Screw Laydown Threading		Insert Screws On Edge	
	IS25	IS35	SN2T	SN3T	SA3T	SA4T	SY3T	SY4T	GTS1	GTS2
CS06- CS20	1/4" I.C.	3/8" I.C.	1/4" I.C.	3/8" I.C.	3/8" I.C.	1/2" I.C.	3/8" I.C.	1/2" I.C.	3/8" I.C.	1/2" I.C.
\$2.75	\$2.75	\$2.75	\$2.75	\$2.75	\$2.75	\$2.75	\$2.75	\$2.75	\$2.75	\$2.75

Lockpins Negative Rake					Clamp Negative Rake		Clamp Screw Negative Rake	
NL-33	NL-33L	NL-34L	NL-44	NL-46	CL-5	CL-20	XNS-35	XNS-47
3/8" I.C.	3/8" I.C.	3/8" I.C.	1/2" I.C.	1/2" I.C.				
\$4.75	\$4.75	\$4.75	\$4.75	\$4.75	\$5.50	\$5.50	\$2.75	\$2.75

Pocket Anvil Laydown Threading				Pocket Shim Negative Rake			
YI3	YE3	YI4	YE4	ICSN-433	IWSN-433	IDSN-433	IVSN-322
3/8" I.C. RH	3/8" I.C. LH	1/2" I.C. RH	1/2" I.C. LH	1/2" I.C.	1/2" I.C.	1/2" I.C.	3/8" I.C.
\$11.50	\$11.50	\$17.50	\$17.50	\$5.50	\$5.50	\$5.50	\$5.50

Clamps Top-Notch / Flo-Lock				Clamp Screws Top-Notch / Flo-Lock		
CM72	CM73	CM74	CM75	B632	C632	C1032
#3 LH	#3 RH	#2 LH	#2 RH	#2	#2	#3
\$10.95	\$10.95	\$14.95	\$14.95	\$2.45	\$2.45	\$2.45

# Versabar® Shank Retrofit / Remanufacture



Extend the Life Of  
Crashed and Seldom  
Used Carbide Bars  
(Inch or Metric Shank)  
By Retrofitting With the  
Versabar® Coupling.  
Then Choose From 38  
Different Modular Head  
Options, RH or LH!

Choose Any  
Head Style  
RH or LH



**Fixed-Pocket Bars All Retrofitted To Versabar!**

## SOLID CARBIDE OR HEAVY METAL SHANK

Shank Diameter		Retrofit/Remanufacture	
Inch	Metric	No Coolant	Coolant Fed
.500	M12	\$105.00	\$115.00
.625	M16	\$145.00	\$155.00
.750	M20	\$185.00	\$195.00
1.000	M25	\$225.00	\$245.00
1.250	M32	\$425.00	\$465.00



**Service Partner:**

**TOOL\$AVER<sup>®</sup>**  
**INDEXABLE TOOL SPECIALISTS**

**ToolSaver, Inc.**

**1227 FM 646 Road N.**

**Dickinson, TX 77539**

**Phone (409) 927-4181 - Fax (409) 927-4183**

**sales@toolsaverinc.com**

**www.toolsaverinc.com**